

LITELINE

2024

Your tap for standard applications.

Order now in our webshop!

For more than 75 years, we have been developing, producing and distributing high-precision products for the industrial, efficient thread production.

Around the world, customers from the automotive and aerospace industry as well as mechanical engineering and medical technology trust in our solutions.

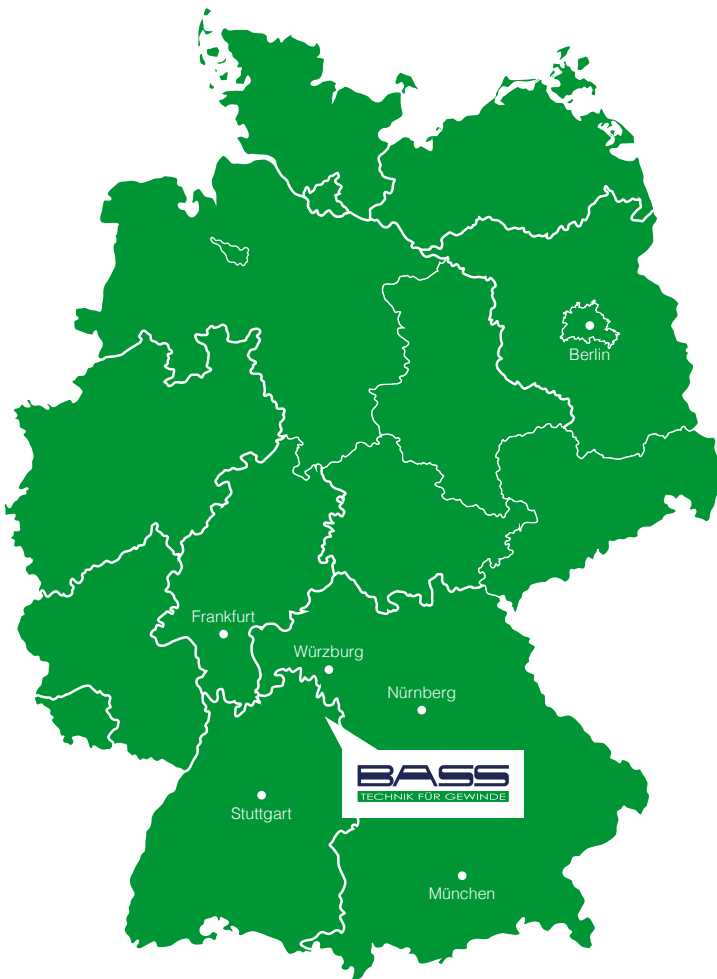

BASS GmbH

Technik für Gewinde
Bass-Strasse 1
97996 Niederstetten
Deutschland · Germany

Tel.: +49 7932 892-0
Fax: +49 7932 892-87
E-Mail: info@bass-tools.com
Web: www.bass-tools.com

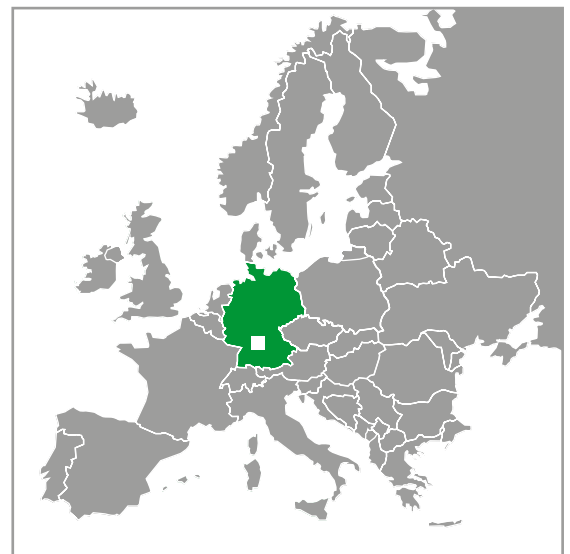

Edition 2 | You can find the current edition of our catalogue on our website.

Printing errors or changes of any kind do not justify any claims. Illustrations may differ from actual items. All data without guarantee.

Our general terms and conditions of sale, delivery and payment conditions apply.
These can be found on our website at www.bass-tools.com/tc

TABLE OF CONTENTS

GENERAL INFORMATION	2
---------------------	---

APPLICATION TABLE	4
-------------------	---

CUTTING TAPS	6
--------------	---

M	6
---	---

MF	16
----	----

G	24
---	----

UNC	28
-----	----

UNF	30
-----	----

STI (EG-M)	32
------------	----

NPT	34
-----	----

GENERAL INFORMATION

With our **LITELINE** we offer quality taps in a comprehensive range of sizes, tolerances and chamfer forms. In the product index (right page) you find an overview of all cutting taps included, specialties marked bold.

For pricing information, please refer to our latest price list, which is available separately.

CUTTING TAPS			
	<p>VARIANT®</p> <ul style="list-style-type: none"> » straight flutes and spiral point » chamfer form B / 3 - 5.5 threads » for through hole » thread depth up to 3xD » chip evacuation forwards 		<p>DOMINANT®</p> <ul style="list-style-type: none"> » spiral flute 40° - 45° » chamfer form C / 2 - 3 threads » chamfer form E / 1.5 - 2 threads » for blind hole » thread depth up to 3xD » chip evacuation backwards

ABBREVIATIONS		
LH = Left hand 	SL = Tools with long shank	HSSE = High speed steel

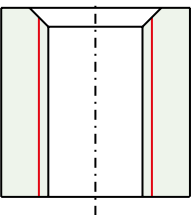
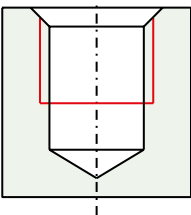
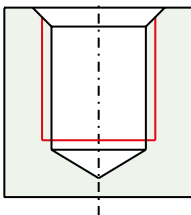
TYPES OF BORE HOLES					
	for through holes (chamfer form B)		for blind holes with normal thread chamfer (chamfer form C)		for blind holes with short thread chamfer (chamfer form E)

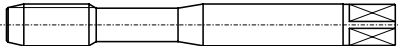
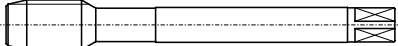
SHANK TYPES			
1	reinforced shank (e.g. DIN 371) 	2	reduced shank (e.g. DIN 376) 

PRODUCT INDEX					
type	series	model	chamfer	thread tol.	page
M – METRIC COARSE THREAD					
through hole	VARIANT LT	TIN	B	4HX	6
through hole	VARIANT LT	TIN	B	6HX	6-7
through hole	VARIANT LT	LH TIN	B	6HX	8
through hole	VARIANT LT	TIN SL	B	6HX	9
through hole	VARIANT LT	TIN	B	6GX	6-7
through hole	VARIANT LT	TIN	B	7GX	6-7
through hole	VARIANT LT	TIN	B	6H+0.1	14
blind hole	DOMINANT LT45	TIN	C	4HX	10
blind hole	DOMINANT LT45	TIN	C	6HX	10-11
blind hole	DOMINANT LT45	LH TIN	C	6HX	12
blind hole	DOMINANT LT45	TIN	C	6GX	10-11
blind hole	DOMINANT LT45	TIN	C	7GX	10-11
blind hole	DOMINANT LT45	TIN SL	C	6HX	13
blind hole	DOMINANT LT45	TIN	C	6H+0.1	15
blind hole	DOMINANT LT45	TIN	E	6HX	12
MF – METRIC FINE THREAD					
through hole	VARIANT LT	TIN	B	6HX	16-17
through hole	VARIANT LT	LH TIN	B	6HX	16-17
through hole	VARIANT LT	TIN SL	B	6HX	18
blind hole	DOMINANT LT45	TIN	C	6HX	20-21
blind hole	DOMINANT LT45	LH TIN	C	6HX	20-21
blind hole	DOMINANT LT45	TIN SL	C	6HX	22
G – BRITISH STANDARD PIPE THREAD					
through hole	VARIANT LT	TIN	B	–	24
through hole	VARIANT LT	TIN SL	B	–	25
blind hole	DOMINANT LT45	TIN	C	–	26
blind hole	DOMINANT LT45	TIN	E	–	26
blind hole	DOMINANT LT45	TIN SL	C	–	27
UNC – UNIFIED COARSE THREAD					
through hole	VARIANT LT	TIN	B	2BX	28
blind hole	DOMINANT LT45	TIN	C	2BX	29
UNF – UNIFIED FINE THREAD					
through hole	VARIANT LT	TIN	B	2BX	30
blind hole	DOMINANT LT45	TIN	C	2BX	31
EG-M – STI METRIC ISO THREAD					
through hole	VARIANT LT	TIN	B	6HX mod	32
blind hole	DOMINANT LT45	TIN	E	6HX mod	33
NPT – AMERICAN STANDARD TAPER PIPE THREAD					
blind hole	DOMINANT LT40	TIN	C	–	34

APPLICATION TABLE

number of revolutions (rpm)

$$n = \frac{v_c \cdot 1000}{\pi \cdot d_1}$$

cutting speed

$$v_c = \frac{n \cdot \pi \cdot d_1}{1000}$$

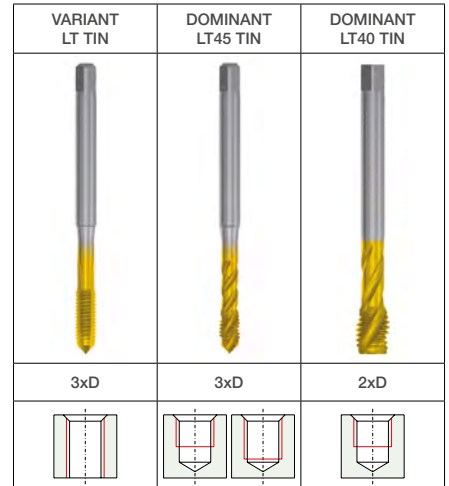

How to proceed





1. Select hole shape
2. Select application
3. Search for cutting speed (vc m/min)

	Application	Examples of materials	R _m N/mm ²	HB	HRC	vc m/min (Tool well suitable – tool suitable)			
P	Steel materials								
	Magnetic soft steel	FeP01	> 100 < 450			20 - 30	20 - 30	2 - 8	
	Construction steel / case hardening steel	En40B	> 300 < 700			20 - 30	20 - 30	2 - 8	
	Carbon steel	080M46	> 400 < 950			20 - 30	20 - 30	2 - 8	
	Alloyed / heat-treatable steel	En19A	> 450 < 950			15 - 30	15 - 30		
	Alloyed steel	BD2	> 800 < 1250	> 235 < 370	> 22 < 40	10 - 20	10 - 20		
M	Stainless steel								
	Ferritic / martensitic steel	420S37	> 450 < 1200			6 - 12	6 - 12		
	Austenitic steel	320S18	> 400 < 950			6 - 12	6 - 12		
	High temperature steel	301S81	> 850 < 1550	> 250 < 455	> 25 < 48				
K	Cast iron								
	Grey cast iron	EN-GJL-200	> 150 < 1000	> 100 < 300					
	Cast iron with nodular graphite	Grade 420/12	> 350 < 1000	> 100 < 350		8 - 20	8 - 20	2 - 8	
	Malleable cast iron	EN-GJMB-350-10	> 300 < 700	> 100 < 200		15 - 25	15 - 25	1 - 8	
	Cast iron with vermicular graphite	EN-GJV-300	> 700 < 1000	> 200 < 300	> 20 < 32	5 - 15	-		
N	Copper								
	Copper non-alloyed	Cu-ETP-2 C 101	> 200 < 400	> 60 < 120		10 - 25	10 - 25		
	Brass (short chipping)	CZ 120	> 350 < 700	> 100 < 200		15 - 35	-		
	Brass (long chipping)	CZ 108	> 150 < 700	> 45 < 200		15 - 35	15 - 35	1 - 8	
	Copper-alu-nickel alloyed (short chipping)	CN 102	> 150 < 700	> 45 < 200		10 - 20	10 - 20		
	Copper-alu-nickel alloyed (long chipping)	CA 104	> 500 < 750	> 150 < 220		15 - 25	15 - 25		
	Special copper alloyed ≤ Ampco 20	CA 105	> 550 < 650	> 160 < 190					
	Special copper alloyed ≥ Ampco 21	AMPCO 21	> 700 < 1500	> 200 < 440	> 21 < 47				
	Aluminium / Magnesium								
	Alu wrought alloy Si ≤0,5%	1B	> 100 < 700	> 30 < 200					
	Alu alloyed Si ≤6%	LM22	> 150 < 700	> 45 < 200		15 - 40	15 - 40	1 - 8	
	Alu alloyed Si >6%	LM9	> 150 < 900	> 45 < 265		15 - 40	15 - 40	1 - 8	
	Magnesium wrought alloy	MAG 101	> 150 < 500	> 45 < 150					
	Synthetics								
	Thermoplastic (long chipping)	Styreme	> 20 < 80						
Duroplastic (short chipping)	Toufnell	> 80 < 110							
Fibre-reinforced plastic	Carbonfibre	> 800 < 1500	> 235 < 440						
Special materials									
Cobalt alloyed		> 400 < 2000	> 120 < 590						
Tungsten alloyed		> 1400 < 1800	> 410 < 530	> 44 < 52					
TiC-hard material			> 440 < 495	> 47 < 50					
Graphite		> 38 < 60							
S	Titanium								
	Titanium non-alloyed	TA.2	> 300 < 700	> 90 < 200					
	Titanium alloyed	TA.10	> 450 < 900	> 135 < 265	> 14 < 27				
	Titanium alloyed	TA.10	> 900 < 1250	> 265 < 370	> 27 < 40				
	Nickel								
	Nickel non-alloyed	BS3072: NA11	> 400 < 600	> 120 < 175					
Nickel alloyed	BS3072: NA13	> 400 < 1200	> 120 < 350	> 12 < 39					
Nickel alloyed	INCONEL alloy718	> 1200 < 1550	> 350 < 455	> 39 < 48					
H	Steel materials								
	Alloyed steel	En19A	> 1100 < 1400	> 325 < 410	> 34 < 45				
	Alloyed steel	251A58	> 1200 < 1550	> 350 < 455	> 39 < 48				
	Hardened steel	708A30	> 1600 < 2000	> 470 < 590	> 48 < 56				
	Hardened steel	BA2			> 56 < 63				

NOTES

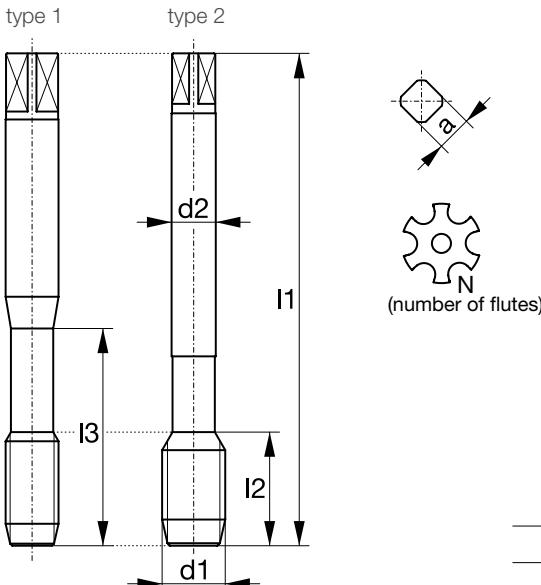
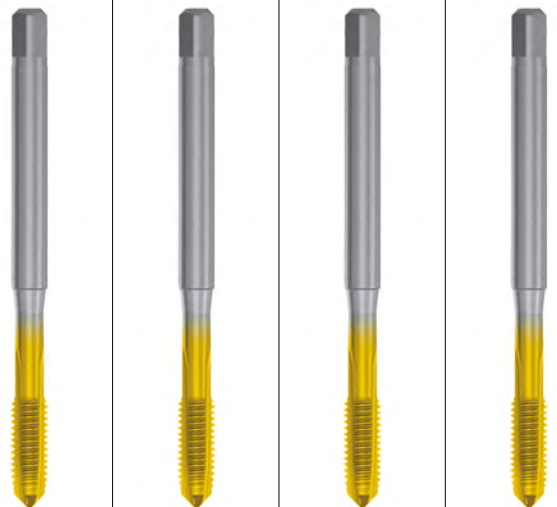
A large grid of small dots, intended for taking notes. The grid consists of approximately 25 columns and 40 rows of dots, spaced evenly across the page.

CUTTING TAPS FOR THROUGH HOLE

M	ISO Metric coarse thread DIN 13		series	VARIANT LT	VARIANT LT	VARIANT LT	VARIANT LT
			model	TIN	TIN	TIN	TIN
			material	HSSE	HSSE	HSSE	HSSE
							
<p>General dimensions DIN 371 / DIN 376</p>			chamfer	B / 3-5.5	B / 3-5.5	B / 3-5.5	B / 3-5.5
			thread tol.	4HX	6HX	6GX	7GX
			shank tol.	h9	h9	h9	h9
			thread depth	3xD	3xD	3xD	3xD
			bore hole				
			P	10 - 30	10 - 30	10 - 30	10 - 30
			M	6 - 12	6 - 12	6 - 12	6 - 12
			K	5 - 25	5 - 25	5 - 25	5 - 25
			N	10 - 40	10 - 40	10 - 40	10 - 40

i For detailed cutting speeds please refer to the application table on page 4.

Ød ₁	P	l ₁	l ₂	l ₃	Ød ₂	a	N	type		identification number		
M 1	0.25	40	5	-	2.5	2.1	2	1	0.75	780000		
M 1.1	0.25	40	5	-	2.5	2.1	2	1	0.85	780001		
M 1.2	0.25	40	5	-	2.5	2.1	2	1	0.95	780002		
M 1.4	0.3	40	7	-	2.5	2.1	2	1	1.1	780003		
M 1.6	0.35	40	8	-	2.5	2.1	2	1	1.25	780004		
M 1.7	0.35	40	8	-	2.5	2.1	2	1	1.3	780005		
M 1.8	0.35	40	8	-	2.5	2.1	2	1	1.45	780006		
M 2	0.4	45	8	-	2.8	2.1	2	1	1.6	780007	780036	780048
M 2.2	0.45	45	9	-	2.8	2.1	2	1	1.75	780008		
M 2.3	0.4	45	9	-	2.8	2.1	2	1	1.9	780009		
M 2.5	0.45	50	9	-	2.8	2.1	2	1	2.05	780010		
M 2.6	0.45	50	9	-	2.8	2.1	2	1	2.1	780011		
M 3	0.5	56	11	18	3.5	2.7	3	1	2.5	780012	780037	780049
M 3	0.5	56	11	-	2.2	-	3	2	2.5	780030		
M 3.5	0.6	56	12	20	4	3	3	1	2.9	780013		
M 4	0.7	63	13	21	4.5	3.4	3	1	3.3	780014	780038	780050
M 4	0.7	63	13	-	2.8	2.1	3	2	3.3	780031		
M 4.5	0.75	70	16	25	6	4.9	3	1	3.7	780015		
M 5	0.8	70	16	25	6	4.9	3	1	4.2	780016	780039	780051
M 5	0.8	70	16	-	3.5	2.7	3	2	4.2	780032		

CUTTING TAPS FOR THROUGH HOLE

M

ISO Metric coarse thread DIN 13



series
model
material

VARIANT
LT
TIN
HSSE

VARIANT
LT
TIN
HSSE

VARIANT
LT
TIN
HSSE

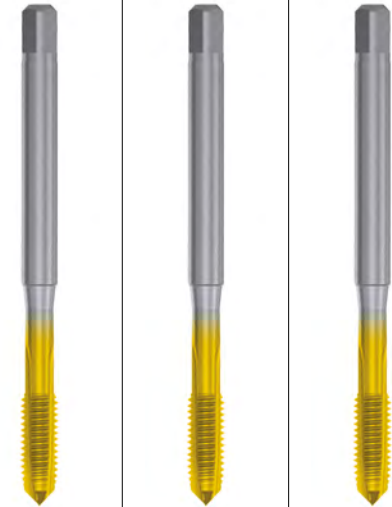
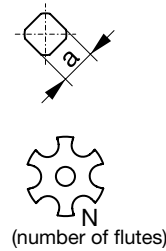
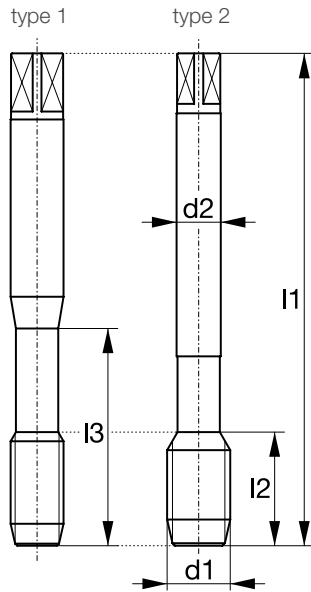

chamfer

B / 3-5.5

B / 3-5.5

B / 3-5.5

thread tol.

6HX

6GX

7GX

shank tol.

h9

h9

h9

thread depth

3xD

3xD

3xD

bore hole



General dimensions
DIN 371 / DIN 376

P

10 - 30

10 - 30

10 - 30

M

6 - 12

6 - 12

6 - 12

K

5 - 25

5 - 25

5 - 25

N

10 - 40





10 - 40

10 - 40

i For detailed cutting speeds please refer to the application table on page 4.

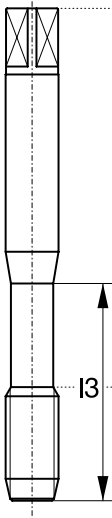
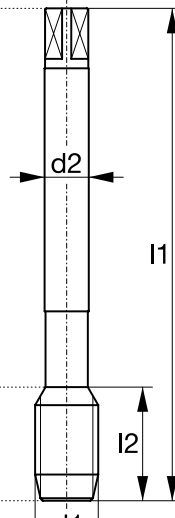
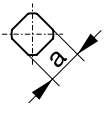
Ød ₁	P	l ₁	l ₂	l ₃	Ød ₂	a	N	type		identification number
M 6	1	80	19	30	6	4.9	3	1	5	780017 780040 780052
M 6	1	80	19	-	4.5	3.4	3	2	5	780033
M 7	1	80	19	30	7	5.5	3	1	6	780018
M 8	1.25	90	22	35	8	6.2	3	1	6.8	780019 780041 780053
M 8	1.25	90	22	-	6	4.9	3	2	6.8	780034
M 10	1.5	100	24	39	10	8	3	1	8.5	780020 780042 780054
M 10	1.5	100	24	-	7	5.5	3	2	8.5	780035
M 12	1.75	110	28	-	9	7	3	2	10.2	780021 780043 780055
M 14	2	110	30	-	11	9	3	2	12	780022 780044
M 16	2	110	32	-	12	9	3	2	14	780023 780045 780056
M 18	2.5	125	34	-	14	11	3	2	15.5	780024
M 20	2.5	140	34	-	16	12	3	2	17.5	780025 780046
M 22	2.5	140	34	-	18	14.5	3	2	19.5	780026
M 24	3	160	38	-	18	14.5	3	2	21	780027 780047
M 27	3	160	38	-	20	16	4	2	24	780028
M 30	3.5	180	45	-	22	18	4	2	26.5	780029

CUTTING TAPS FOR THROUGH HOLE

M	ISO Metric coarse thread DIN 13		series	VARIANT LT LH TIN HSSE			
			model				
			material				
<div style="display: flex; justify-content: space-around;"> <div style="text-align: center;"> <p>type 1</p>  </div> <div style="text-align: center;"> <p>type 2</p>  </div> </div> <div style="margin-top: 20px;">  <p style="text-align: center;">a</p>  <p style="text-align: center;">N (number of flutes)</p> </div>							
chamfer	B / 3-5.5						
thread tol.	6HX						
shank tol.	h9						
thread depth	3xD						
bore hole							
	P	10 - 30					
	M	6 - 12					
	K	5 - 25					
	N	10 - 40					

General dimensions
DIN 371 / DIN 376

i For detailed cutting speeds please refer to the application table on page 4.

$\text{Ø}d_1$	P	l_1	l_2	l_3	$\text{Ø}d_2$	a	N	type		identification number
M 3	0.5	56	11	18	3.5	2.7	3	1	2.5	780080
M 4	0.7	63	13	21	4.5	3.4	3	1	3.3	780081
M 5	0.8	70	16	25	6	4.9	3	1	4.2	780082
M 6	1	80	19	30	6	4.9	3	1	5	780083
M 8	1.25	90	22	35	8	6.2	3	1	6.8	780084
M 10	1.5	100	24	39	10	8	3	1	8.5	780085
M 12	1.75	110	28	-	9	7	3	2	10.2	780086
M 14	2	110	30	-	11	9	3	2	12	780087
M 16	2	110	32	-	12	9	3	2	14	780088
M 20	2.5	140	34	-	16	12	3	2	17.5	780089
M 24	3	160	38	-	18	14.5	3	2	21	780090

CUTTING TAPS FOR THROUGH HOLE
M

 ISO Metric coarse
thread DIN 13

series
model
material

VARIANT LT
TIN SL
HSSE

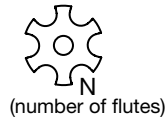
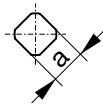
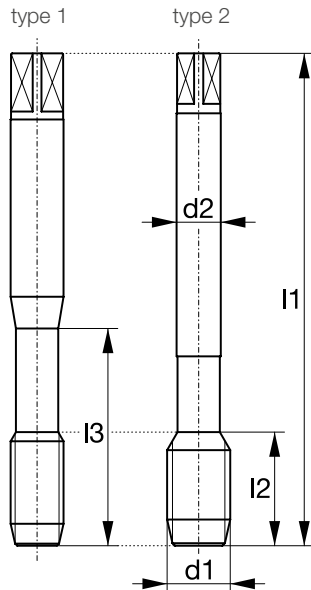

chamfer B / 3-5.5

thread tol. 6HX

shank tol. h9

thread depth 3xD

bore hole



General dimensions
 ~ DIN 371/ ~ DIN 376





P	10 - 30
M	6 - 12
K	5 - 25
N	10 - 40

i For detailed cutting speeds please refer to the application table on page 4.

$\varnothing d_1$	P	l_1	l_2	l_3	$\varnothing d_2$	a	N	type		identification number
M 3	0.5	100	11	20	3.5	2.7	3	1	2.5	780065
M 4	0.7	125	13	27	4.5	3.4	3	1	3.3	780066
M 4	0.7	125	13	-	2.8	2.1	3	2	3.3	780075
M 5	0.8	160	16	33	6	4.9	3	1	4.2	780067
M 5	0.8	160	16	-	3.5	2.7	3	2	4.2	780076
M 6	1	160	19	40	6	4.9	3	1	5	780068
M 6	1	160	19	-	4.5	3.4	3	2	5	780077
M 8	1.25	180	22	52	8	6.2	3	1	6.8	780069
M 8	1.25	180	22	-	6	4.9	3	2	6.8	780078
M 10	1.5	200	24	65	10	8	3	1	8.5	780070
M 10	1.5	200	24	-	7	5.5	3	2	8.5	780079
M 12	1.75	200	28	-	9	7	3	2	10.2	780071
M 14	2	200	30	-	11	9	3	2	12	780072
M 16	2	200	32	-	12	9	3	2	14	780073
M 20	2.5	200	34	-	16	12	3	2	17.5	780074

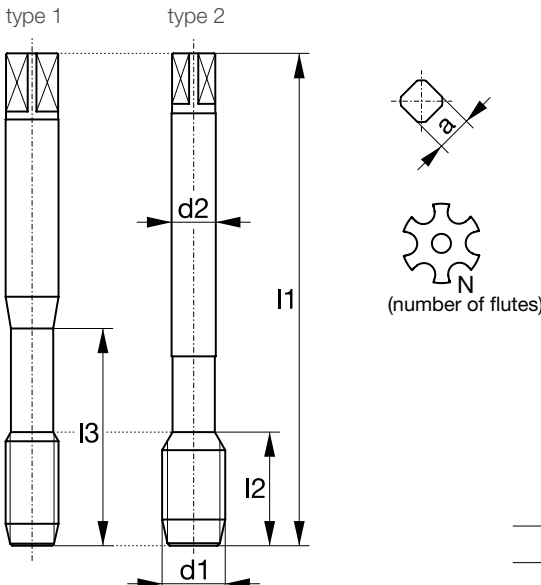
CUTTING TAPS FOR BLIND HOLE

M	ISO Metric coarse thread DIN 13		series	DOMINANT LT45	DOMINANT LT45	DOMINANT LT45	DOMINANT LT45
			model	TIN	TIN	TIN	TIN
			material	HSSE	HSSE	HSSE	HSSE

	chamfer	C / 2-3	C / 2-3	C / 2-3	C / 2-3
	thread tol.	4HX	6HX	6GX	7GX
	shank tol.	h9	h9	h9	h9
	thread depth	3xD	3xD	3xD	3xD
General dimensions DIN 371 / DIN 376	bore hole				
	P	10 - 30	10 - 30	10 - 30	10 - 30
	M	6 - 12	6 - 12	6 - 12	6 - 12
	K	8 - 25	8 - 25	8 - 25	8 - 25
	N	10 - 40	10 - 40	10 - 40	10 - 40

i For detailed cutting speeds please refer to the application table on page 4.

Ød ₁	P	l ₁	l ₂	l ₃	Ød ₂	a	N	type		identification number
M 1	0.25	40	5	-	2.5	2.1	2	1	0.75	780091
M 1.1	0.25	40	5	-	2.5	2.1	2	1	0.85	780092
M 1.2	0.25	40	5	-	2.5	2.1	2	1	0.95	780093
M 1.4	0.3	40	6	-	2.5	2.1	2	1	1.1	780094
M 1.6	0.35	40	7	-	2.5	2.1	2	1	1.25	780095
M 1.7	0.35	40	8	-	2.5	2.1	2	1	1.3	780096
M 1.8	0.35	40	8	-	2.5	2.1	2	1	1.45	780097
M 2	0.4	45	3.2	10	2.8	2.1	2	1	1.6	780098 780139 780151
M 2.2	0.45	45	3.6	11	2.8	2.1	2	1	1.75	780099
M 2.3	0.4	45	3.6	12	2.8	2.1	2	1	1.9	780100
M 2.5	0.45	50	3.6	13	2.8	2.1	2	1	2.05	780101
M 2.6	0.45	50	3.6	13	2.8	2.1	2	1	2.1	780102
M 3	0.5	56	4	18	3.5	2.7	3	1	2.5	780103 780140 780152
M 3	0.5	56	4	-	2.2	-	3	2	2.5	780121
M 3.5	0.6	56	4.8	20	4	3	3	1	2.9	780104
M 4	0.7	63	5.6	21	4.5	3.4	3	1	3.3	780105 780141 780153
M 4	0.7	63	5.6	-	2.8	2.1	3	2	3.3	780122
M 4.5	0.75	70	6	25	6	4.9	3	1	3.7	780106
M 5	0.8	70	6.4	25	6	4.9	3	1	4.2	780142 780154
M 5	0.8	70	6.4	-	3.5	2.7	3	2	4.2	780123
M 5	0.8	70	6.4	25	6	4.9	3	1	4.2	780107

CUTTING TAPS FOR BLIND HOLE

M

ISO Metric coarse thread DIN 13



series
model
material

**DOMINANT
LT45
TIN
HSSE**

**DOMINANT
LT45
TIN
HSSE**

**DOMINANT
LT45
TIN
HSSE**

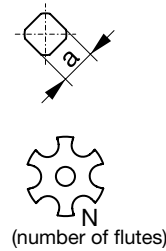
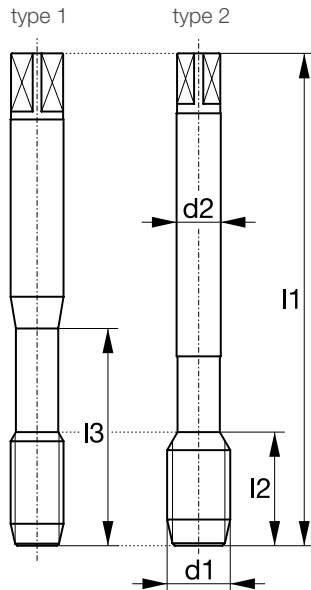

chamfer

C / 2-3

C / 2-3

C / 2-3

thread tol.

6HX

6GX

7GX

shank tol.

h9

h9

h9

thread depth

3xD

3xD

3xD

bore hole



**General dimensions
DIN 371 / DIN 376**

P

10 - 30

10 - 30

10 - 30

M

6 - 12

6 - 12

6 - 12

K

8 - 25

8 - 25

8 - 25

N

10 - 40

10 - 40

10 - 40

i For detailed cutting speeds please refer to the application table on page 4.

Ød ₁	P	l ₁	l ₂	l ₃	Ød ₂	a	N	type		identification number		
M 6	1	80	8	30	6	4.9	3	1	5	780108	780143	780155
M 6	1	80	8	-	4.5	3.4	3	2	5	780124		
M 7	1	80	8	30	7	5.5	3	1	6	780109		
M 8	1.25	90	10	35	8	6.2	3	1	6.8	780110	780144	780156
M 8	1.25	90	10	-	6	4.9	3	2	6.8	780125		
M 10	1.5	100	12	39	10	8	3	1	8.5	780111	780145	780157
M 10	1.5	100	12	-	7	5.5	3	2	8.5	780126		
M 12	1.75	110	14	-	9	7	3	2	10.2	780112	780146	780158
M 14	2	110	16	-	11	9	3	2	12	780113	780147	
M 16	2	110	16	-	12	9	3	2	14	780114	780148	780159
M 18	2.5	125	25	-	14	11	4	2	15.5	780115		
M 20	2.5	140	25	-	16	12	4	2	17.5	780116	780149	
M 22	2.5	140	25	-	18	14.5	4	2	19.5	780117		
M 24	3	160	30	-	18	14.5	4	2	21	780118	780150	
M 27	3	160	36	-	20	16	4	2	24	780119		
M 30	3.5	180	42	-	22	18	4	2	26.5	780120		

CUTTING TAPS FOR BLIND HOLE

M

ISO Metric coarse thread DIN 13



series

model

material

**DOMINANT
LT45
TIN
HSSE**

**DOMINANT
LT45
LH TIN
HSSE**

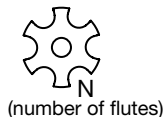
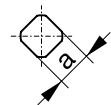
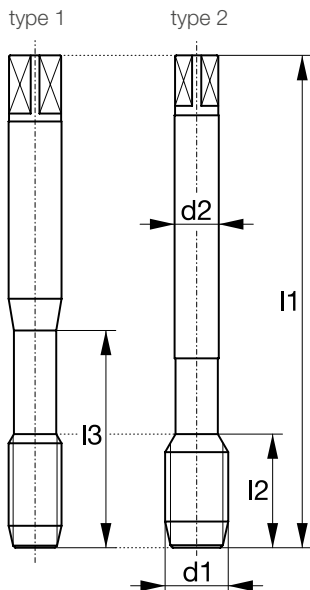

(number of flutes)



chamfer

E / 1.5-2

C / 2-3

thread tol.

6HX

6HX

shank tol.

h9

h9

thread depth

3xD

3xD

bore hole



General dimensions

DIN 371 / DIN 376

P

10 - 30

10 - 30

M

6 - 12

6 - 12

K

8 - 25

8 - 25

N

10 - 40

10 - 40

i For detailed cutting speeds please refer to the application table on page 4.

Ød ₁	P	l ₁	l ₂	l ₃	Ød ₂	a	N	type		identification number
M 2	0.4	45	3.2	10	2.8	2.1	2	1	1.6	780127
M 3	0.5	56	4	18	3.5	2.7	3	1	2.5	780128 780183
M 4	0.7	63	5.6	21	4.5	3.4	3	1	3.3	780129 780184
M 5	0.8	70	6.4	25	6	4.9	3	1	4.2	780130 780185
M 6	1	80	8	30	6	4.9	3	1	5	780131 780186
M 8	1.25	90	10	35	8	6.2	3	1	6.8	780132 780187
M 10	1.5	100	12	39	10	8	3	1	8.5	780133 780188
M 12	1.75	110	14	-	9	7	3	2	10.2	780134 780189
M 14	2	110	16	-	11	9	3	2	12	780135 780190
M 16	2	110	16	-	12	9	3	2	14	780136 780191
M 20	2.5	140	25	-	16	12	4	2	17.5	780137 780192
M 24	3	160	30	-	18	14.5	4	2	21	780138 780193

CUTTING TAPS FOR BLIND HOLE

M

ISO Metric coarse thread DIN 13



series

**DOMINANT
LT45**

model

TIN SL

material

HSSE

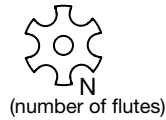
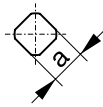
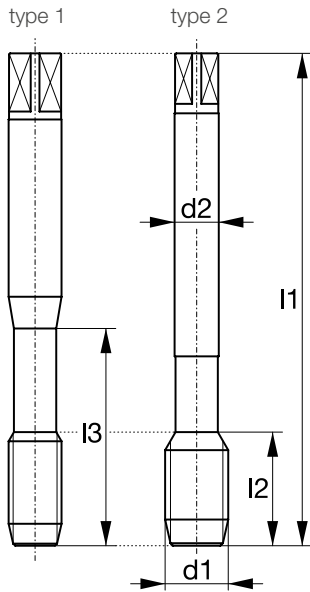

chamfer

C / 2-3

thread tol.

6HX

shank tol.

h9

thread depth

3xD

General dimensions

~ DIN 371 / ~ DIN 376

bore hole



P

10 - 30

M

6 - 12

K

8 - 25

N

10 - 40

i For detailed cutting speeds please refer to the application table on page 4.

Ød ₁	P	l ₁	l ₂	l ₃	Ød ₂	a	N	type		identification number
M 3	0.5	100	4	18	3.5	2.7	3	1	2.5	780168
M 4	0.7	125	5.6	21	4.5	3.4	3	1	3.3	780169
M 4	0.7	125	5.6	-	2.8	2.1	3	2	3.3	780178
M 5	0.8	160	6.4	25	6	4.9	3	1	4.2	780170
M 5	0.8	160	6.4	-	3.5	2.7	3	2	4.2	780179
M 6	1	160	8	30	6	4.9	3	1	5	780171
M 6	1	160	8	-	4.5	3.4	3	2	5	780180
M 8	1.25	180	10	35	8	6.2	3	1	6.8	780172
M 8	1.25	180	10	-	6	4.9	3	2	6.8	780181
M 10	1.5	200	12	39	10	8	3	1	8.5	780173
M 10	1.5	200	12	-	7	5.5	3	2	8.5	780182
M 12	1.75	200	14	-	9	7	3	2	10.2	780174
M 14	2	200	16	-	11	9	3	2	12	780175
M 16	2	200	16	-	12	9	3	2	14	780176
M 20	2.5	200	25	-	16	12	4	2	17.5	780177

CUTTING TAPS FOR THROUGH HOLE

M	ISO Metric coarse thread DIN 13		series	VARIANT LT TIN HSSE			
			model				
			material				

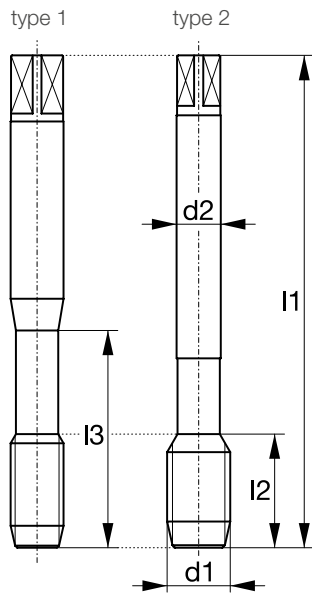

chamfer	B / 3-5.5			
thread tol.	6H+0.1			
shank tol.	h9			
thread depth	3xD			
bore hole				

General dimensions
DIN 371 / DIN 376

P	10 - 30			
M	6 - 12			
K	5 - 25			
N	10 - 40			

i For detailed cutting speeds please refer to the application table on page 4.

Ød ₁	P	l ₁	l ₂	l ₃	Ød ₂	a	N	type		identification number
M 3	0.5	56	11	18	3.5	2.7	3	1	2.6	780057
M 4	0.7	63	13	21	4.5	3.4	3	1	3.4	780058
M 5	0.8	70	16	25	6	4.9	3	1	4.3	780059
M 6	1	80	19	30	6	4.9	3	1	5.1	780060
M 8	1.25	90	22	35	8	6.2	3	1	6.9	780061
M 10	1.5	100	24	39	10	8	3	1	8.6	780062
M 12	1.75	110	28	-	9	7	3	2	10.3	780063
M 16	2	110	32	-	12	9	3	2	14.1	780064

CUTTING TAPS FOR BLIND HOLE

M

ISO Metric coarse thread DIN 13



series

**DOMINANT
LT45**

model

TIN

material

HSSE

type 1

type 2

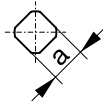
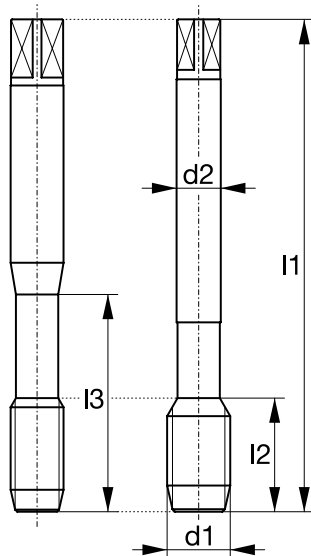

(number of flutes)



chamfer

C / 2-3

thread tol.

6H+0.1

shank tol.

h9

thread depth

3xD

General dimensions

DIN 371 / DIN 376

bore hole



P

10 - 30

M

6 - 12

K

8 - 25

N

10 - 40

i For detailed cutting speeds please refer to the application table on page 4.

Ød ₁	P	l ₁	l ₂	l ₃	Ød ₂	a	N	type		identification number
M 3	0.5	56	4	18	3.5	2.7	3	1	2.6	780160
M 4	0.7	63	5.6	21	4.5	3.4	3	1	3.4	780161
M 5	0.8	70	6.4	25	6	4.9	3	1	4.3	780162
M 6	1	80	8	30	6	4.9	3	1	5.1	780163
M 8	1.25	90	10	35	8	6.2	3	1	6.9	780164
M 10	1.5	100	12	39	10	8	3	1	8.6	780165
M 12	1.75	110	14	-	9	7	3	2	10.3	780166
M 16	2	110	16	-	12	9	3	2	14.1	780167

CUTTING TAPS FOR THROUGH HOLE

MF

ISO Metric fine thread DIN 13



series
model
material

VARIANT
LT
TIN
HSSE

VARIANT
LT
LH TIN
HSSE

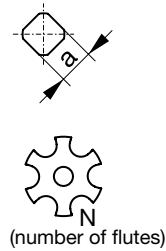
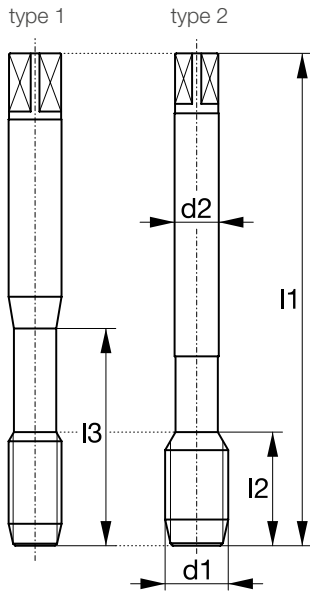

General dimensions
DIN 374

chamfer	B / 3-5.5	B / 3-5.5		
thread tol.	6HX	6HX		
shank tol.	h9	h9		
thread depth	3xD	3xD		
bore hole				
P	10 - 30	10 - 30		
M	6 - 12	6 - 12		
K	5 - 25	5 - 25		
N	10 - 40	10 - 40		

i For detailed cutting speeds please refer to the application table on page 4.

$\varnothing d_1$	P	l_1	l_2	l_3	$\varnothing d_2$	a	N	type		identification number	
MF 2.5	0.35	50	9	-	1.8	-	2	2	2.15	780194	
MF 2.6	0.35	50	9	-	1.8	-	2	2	2.25	780195	
MF 3	0.35	56	8	-	2.2	-	3	2	2.65	780196	
MF 3.5	0.35	56	9	-	2.5	2.1	3	2	3.15	780197	
MF 4	0.35	63	10	-	2.8	2.1	3	2	3.65	780198	
MF 4	0.5	63	10	-	2.8	2.1	3	2	3.5	780199	
MF 4.5	0.5	70	12	-	3.5	2.7	3	2	4	780200	
MF 5	0.5	70	16	-	3.5	2.7	3	2	4.5	780201	
MF 6	0.5	80	14	-	4.5	3.4	3	2	5.5	780202	
MF 6	0.75	80	14	-	4.5	3.4	3	2	5.2	780203	
MF 6.5	0.75	80	14	-	5.5	4.3	3	2	5.75	780204	
MF 7	0.5	80	14	-	5.5	4.3	3	2	6.5	780205	
MF 8	0.75	80	22	-	6	4.9	3	2	7.2	780206	
MF 8	1	90	22	-	6	4.9	3	2	7	780207	780235
MF 9	1	90	22	-	7	5.5	3	2	8	780208	
MF 10	0.75	90	20	-	7	5.5	3	2	9.2	780209	
MF 10	1	90	20	-	7	5.5	3	2	9	780210	780236
MF 10	1.25	100	24	-	7	5.5	3	2	8.8	780211	780237
MF 11	1	90	20	-	8	6.2	3	2	10	780212	

CUTTING TAPS FOR THROUGH HOLE

MF

ISO Metric fine thread DIN 13



series
model
material

VARIANT
LT
TIN
HSSE

VARIANT
LT
LH TIN
HSSE

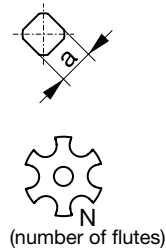
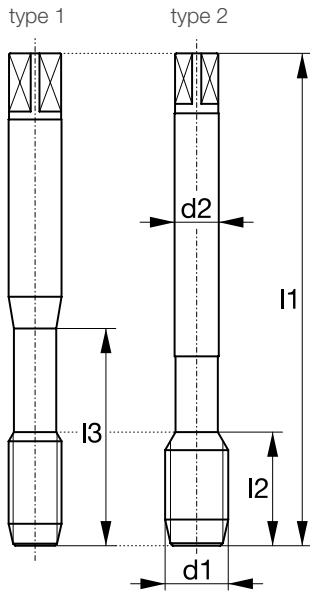

General dimensions
DIN 374

chamfer	B / 3-5.5	B / 3-5.5		
thread tol.	6HX	6HX		
shank tol.	h9	h9		
thread depth	3xD	3xD		
bore hole				
P	10 - 30	10 - 30		
M	6 - 12	6 - 12		
K	5 - 25	5 - 25		
N	10 - 40	10 - 40		

i For detailed cutting speeds please refer to the application table on page 4.

Ød ₁	P	l ₁	l ₂	l ₃	Ød ₂	a	N	type		identification number	
MF 12	0.5	100	22	-	9	7	3	2	11.5	780213	
MF 12	0.75	100	22	-	9	7	3	2	11.2	780214	
MF 12	1	100	22	-	9	7	3	2	11	780215	
MF 12	1.25	100	22	-	9	7	3	2	10.8	780216	780238
MF 12	1.5	100	22	-	9	7	3	2	10.5	780217	780239
MF 13	1	100	22	-	11	9	3	2	12	780218	
MF 14	1.5	100	22	-	11	9	3	2	12.5	780219	
MF 16	1.5	100	22	-	12	9	3	2	14.5	780220	780240
MF 18	1	110	25	-	14	11	3	2	17	780221	
MF 18	1.5	110	25	-	14	11	3	2	16.5	780222	
MF 20	1.5	125	25	-	16	12	3	2	18.5	780223	780241
MF 22	1.5	125	25	-	18	14.5	3	2	20.5	780224	
MF 24	1.5	140	28	-	18	14.5	3	2	22.5	780225	780242
MF 26	1.5	140	28	-	18	14.5	4	2	24.5	780226	
MF 30	1.5	150	28	-	22	18	4	2	28.5	780227	

CUTTING TAPS FOR THROUGH HOLE

MF

ISO Metric fine thread DIN 13



series
model
material

VARIANT
LT
TIN SL
HSSE

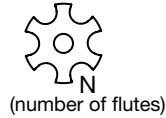
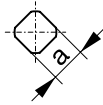
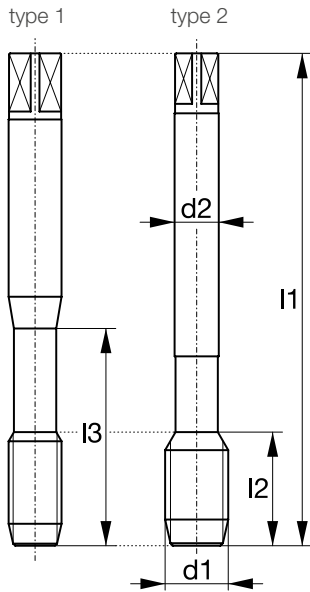

General dimensions
~ DIN 374

chamfer	B / 3-5.5			
thread tol.	6HX			
shank tol.	h9			
thread depth	3xD			
bore hole				
P	10 - 30			
M	6 - 12			
K	5 - 25			
N	10 - 40			

i For detailed cutting speeds please refer to the application table on page 4.

Ød ₁	P	l ₁	l ₂	l ₃	Ød ₂	a	N	type		identification number
MF 8	1	180	22	-	6	4.9	3	2	7	780228
MF 10	1	180	20	-	7	5.5	3	2	9	780229
MF 10	1.25	200	24	-	7	5.5	3	2	8.8	780230
MF 12	1.25	200	22	-	9	7	3	2	10.8	780231
MF 12	1.5	200	22	-	9	7	3	2	10.5	780232
MF 16	1.5	200	22	-	12	9	3	2	14.5	780233
MF 20	1.5	250	25	-	16	12	3	2	18.5	780234

NOTES

A large grid of small dots for taking notes, covering most of the page.

CUTTING TAPS FOR BLIND HOLE

MF

ISO Metric fine thread DIN 13



series
model
material

DOMINANT LT45
TIN
HSSE

DOMINANT LT45
LH TIN
HSSE

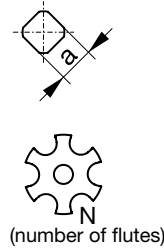
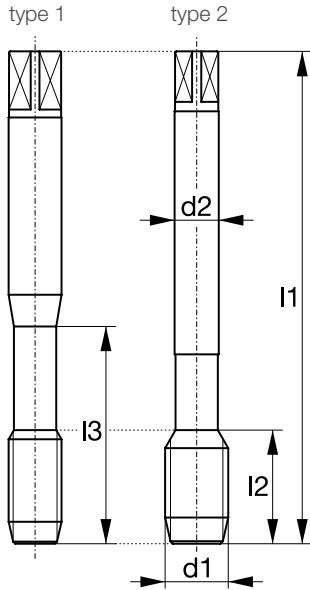

**General dimensions
DIN 374**

chamfer	C / 2-3	C / 2-3		
thread tol.	6HX	6HX		
shank tol.	h9	h9		
thread depth	3xD	3xD		
bore hole				
P	10 - 30	10 - 30		
M	6 - 12	6 - 12		
K	8 - 25	8 - 25		
N	10 - 40	10 - 40		

i For detailed cutting speeds please refer to the application table on page 4.

$\varnothing d_1$	P	l_1	l_2	l_3	$\varnothing d_2$	a	N	type		identification number	
MF 2.5	0.35	50	9	-	1.8	-	2	2	2.15	780243	
MF 2.6	0.35	50	9	-	1.8	-	2	2	2.25	780244	
MF 3	0.35	56	4	-	2.2	-	3	2	2.65	780245	
MF 3.5	0.35	56	4.8	-	2.5	2.1	3	2	3.15	780246	
MF 4	0.35	63	5.6	-	2.8	2.1	3	2	3.65	780247	
MF 4	0.5	63	5.6	-	2.8	2.1	3	2	3.5	780248	
MF 4.5	0.5	70	6	-	3.5	2.7	3	2	4	780249	
MF 5	0.5	70	6.4	-	3.5	2.7	3	2	4.5	780250	
MF 6	0.5	80	8	-	4.5	3.4	3	2	5.5	780251	
MF 6	0.75	80	8	-	4.5	3.4	3	2	5.25	780252	
MF 6.5	0.75	80	8	-	5.5	4.3	3	2	5.75	780253	
MF 7	0.5	80	8	-	5.5	4.3	3	2	6.5	780254	
MF 8	0.75	80	8	-	6	4.9	3	2	7.25	780255	
MF 8	1	90	10	-	6	4.9	3	2	7	780256	780284
MF 9	1	90	10	-	7	5.5	3	2	8	780257	
MF 10	0.75	90	10	-	7	5.5	3	2	9.25	780258	
MF 10	1	90	10	-	7	5.5	3	2	9	780259	780285
MF 10	1.25	100	12	-	7	5.5	3	2	8.75	780260	780286
MF 11	1	90	12	-	8	6.2	3	2	10	780261	

CUTTING TAPS FOR BLIND HOLE

MF

ISO Metric fine thread DIN 13





series
model
material

**DOMINANT
LT45
TIN
HSSE**

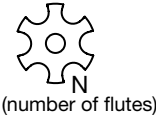
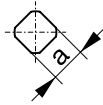
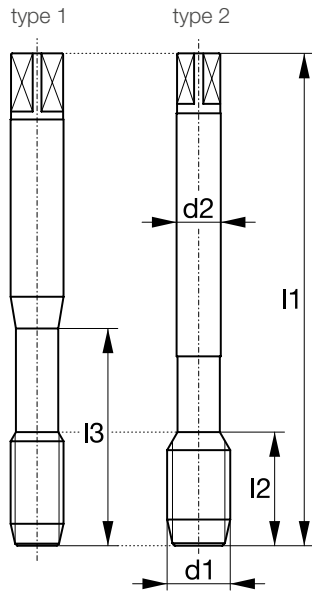
**DOMINANT
LT45
LH TIN
HSSE**



**General dimensions
DIN 374**

chamfer	C / 2-3	C / 2-3		
thread tol.	6HX	6HX		
shank tol.	h9	h9		
thread depth	3xD	3xD		
bore hole				
P	10 - 30	10 - 30		
M	6 - 12	6 - 12		
K	8 - 25	8 - 25		
N	10 - 40	10 - 40		

i For detailed cutting speeds please refer to the application table on page 4.

Ød ₁	P	l ₁	l ₂	l ₃	Ød ₂	a	N	type		identification number	
MF 12	0.5	100	8	-	9	7	3	2	11.5	780262	
MF 12	0.75	100	10	-	9	7	3	2	11.25	780263	
MF 12	1	100	12	-	9	7	3	2	11	780264	
MF 12	1.25	100	12	-	9	7	3	2	10.75	780265	780287
MF 12	1.5	100	14	-	9	7	3	2	10.5	780266	780288
MF 13	1	100	12	-	11	9	3	2	12	780267	
MF 14	1.5	100	16	-	11	9	3	2	12.5	780268	
MF 16	1.5	100	16	-	12	9	3	2	14.5	780269	780289
MF 18	1	110	16	-	14	11	4	2	17	780270	
MF 18	1.5	110	16	-	14	11	4	2	16.5	780271	
MF 20	1.5	125	16	-	16	12	4	2	18.5	780272	780290
MF 22	1.5	125	16	-	18	14.5	4	2	20.5	780273	
MF 24	1.5	140	16	-	18	14.5	4	2	22.5	780274	780291
MF 26	1.5	140	24	-	18	14.5	4	2	24.5	780275	
MF 30	1.5	150	36	-	22	18	4	2	28.5	780276	

CUTTING TAPS FOR BLIND HOLE

MF

ISO Metric fine thread DIN 13



series
model
material

**DOMINANT
LT45
TIN SL
HSSE**

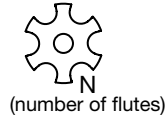
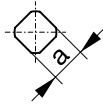
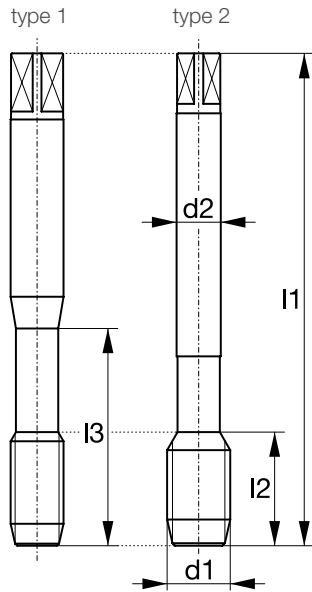

chamfer
thread tol.
shank tol.
thread depth

C / 2-3
6HX
h9
3xD

General dimensions
~ DIN 374

bore hole



P
M
K
N

10 - 30
6 - 12
8 - 25
10 - 40

i For detailed cutting speeds please refer to the application table on page 4.

Ød ₁	P	l ₁	l ₂	l ₃	Ød ₂	a	N	type		identification number
MF 8	1	180	10	-	6	4.9	3	2	7	780277
MF 10	1	180	10	-	7	5.5	3	2	9	780278
MF 10	1.25	200	12	-	7	5.5	3	2	8.75	780279
MF 12	1.25	200	12	-	9	7	3	2	10.75	780280
MF 12	1.5	200	14	-	9	7	3	2	10.5	780281
MF 16	1.5	200	16	-	12	9	3	2	14.5	780282
MF 20	1.5	250	16	-	16	12	4	2	18.5	780283

NOTES

A large grid of small dots, intended for taking notes. The grid consists of approximately 30 columns and 40 rows of dots, covering most of the page area.

CUTTING TAPS FOR THROUGH HOLE

G

British standard
pipe thread
DIN EN ISO 228



series
model
material

VARIANT
LT
TIN
HSSE

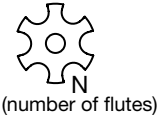
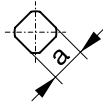
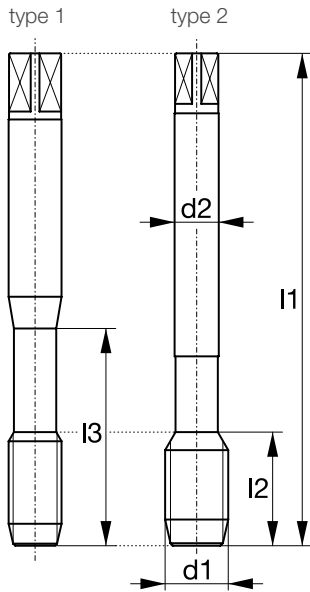

General dimensions
DIN 5156

chamfer	B / 3-5.5			
thread tol.	-			
shank tol.	h9			
thread depth	3xD			
bore hole				
P	10 - 30			
M	6 - 12			
K	5 - 25			
N	10 - 40			

i For detailed cutting speeds please refer to the application table on page 4.

$\varnothing d_1$	P	l_1	l_2	l_3	$\varnothing d_2$	a	N	type		identification number
G 1/16"	28	90	20	-	6	4.9	3	2	6.8	780314
G 1/8"	28	90	20	-	7	5.5	3	2	8.8	780315
G 1/4"	19	100	22	-	11	9	3	2	11.8	780316
G 3/8"	19	100	22	-	12	9	3	2	15.25	780317
G 1/2"	14	125	25	-	16	12	3	2	19	780318
G 5/8"	14	125	25	-	18	14.5	3	2	21	780319
G 3/4"	14	140	28	-	20	16	4	2	24.5	780320
G 1"	11	160	30	-	25	20	4	2	30.75	780321

CUTTING TAPS FOR THROUGH HOLE

G

British standard
pipe thread
DIN EN ISO 228



series
model
material

VARIANT
LT
TIN SL
HSSE

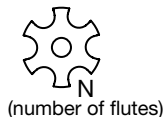
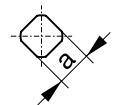
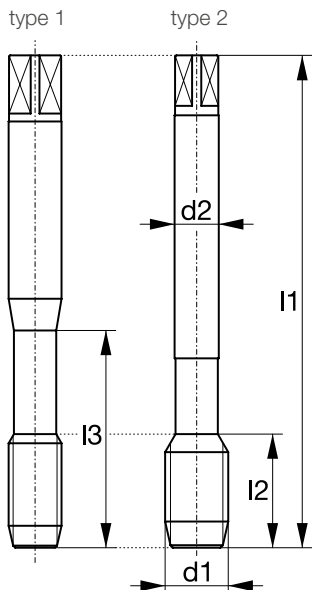

General dimensions
~ DIN 5156

chamfer	B / 3-5.5			
thread tol.	-			
shank tol.	h9			
thread depth	3xD			
bore hole				
P	10 - 30			
M	6 - 12			
K	5 - 25			
N	10 - 40			

i For detailed cutting speeds please refer to the application table on page 4.

Ød ₁	P	l ₁	l ₂	l ₃	Ød ₂	a	N	type		identification number
G 1/8"	28	180	20	-	7	5.5	3	2	8.8	780322
G 1/4"	19	200	22	-	11	9	3	2	11.8	780323
G 3/8"	19	200	22	-	12	9	3	2	15.25	780324
G 1/2"	14	250	25	-	16	12	3	2	19	780325
G 3/4"	14	280	28	-	20	16	4	2	24.5	780326
G 1"	11	280	30	-	25	20	4	2	30.75	780327

CUTTING TAPS FOR BLIND HOLE

G

British standard
pipe thread
DIN EN ISO 228



series
model
material

**DOMINANT
LT45
TIN
HSSE**

**DOMINANT
LT45
TIN
HSSE**

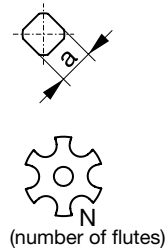
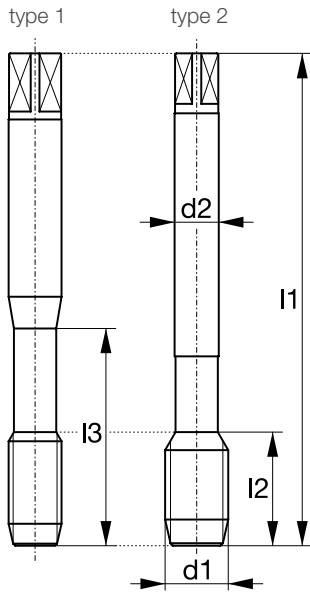

General dimensions
DIN 5156

chamfer	C / 2-3	E / 1.5-2		
thread tol.	-	-		
shank tol.	h9	h9		
thread depth	3xD	3xD		
bore hole				
P	10 - 30	10 - 30		
M	6 - 12	6 - 12		
K	8 - 25	8 - 25		
N	10 - 40	10 - 40		

i For detailed cutting speeds please refer to the application table on page 4.

$\varnothing d_1$	P	l_1	l_2	l_3	$\varnothing d_2$	a	N	type		identification number
G 1/16"	28	90	9.1	-	6	4.9	3	2	6.8	780328
G 1/8"	28	90	9.1	-	7	5.5	3	2	8.8	780329 780342
G 1/4"	19	100	13.4	-	11	9	3	2	11.8	780330 780343
G 3/8"	19	100	13.4	-	12	9	4	2	15.25	780331 780344
G 1/2"	14	125	18.2	-	16	12	4	2	19	780332 780345
G 5/8"	14	125	18.2	-	18	14.5	4	2	21	780333
G 3/4"	14	140	28	-	20	16	4	2	24.5	780334 780346
G 1"	11	160	30	-	25	20	4	2	30.75	780335 780347

CUTTING TAPS FOR BLIND HOLE

G

British standard
pipe thread
DIN EN ISO 228



series
model
material

**DOMINANT
LT45
TIN SL
HSSE**

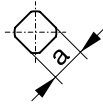
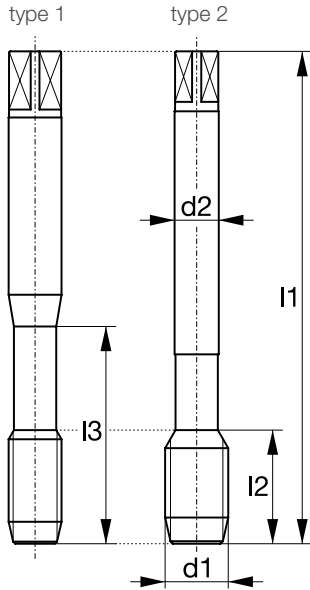

chamfer	C / 2-3
thread tol.	-
shank tol.	h9
thread depth	3xD
bore hole	

General dimensions
~ DIN 5156

P	10 - 30		
M	6 - 12		
K	8 - 25		
N	10 - 40		

i For detailed cutting speeds please refer to the application table on page 4.

Ød ₁	P	l ₁	l ₂	l ₃	Ød ₂	a	N	type		identification number
G 1/8"	28	180	9.1	-	7	5.5	3	2	8.8	780336
G 1/4"	19	200	13.4	-	11	9	3	2	11.8	780337
G 3/8"	19	200	13.4	-	12	9	4	2	15.25	780338
G 1/2"	14	250	18.2	-	16	12	4	2	19	780339
G 3/4"	14	280	28	-	20	16	4	2	24.5	780340
G 1"	11	280	30	-	25	20	4	2	30.75	780341

CUTTING TAPS FOR THROUGH HOLE

UNC

Unified coarse thread ASME B1.1



series
model
material

VARIANT
LT
TIN
HSSE

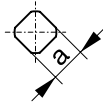
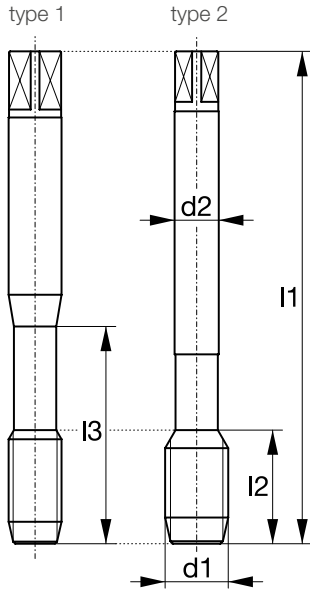

chamfer	B / 3-5.5
thread tol.	2BX
shank tol.	h9
thread depth	3xD
bore hole	

General dimensions
DIN 2184-1

P	10 - 30			
M	6 - 12			
K	5 - 25			
N	10 - 40			

i For detailed cutting speeds please refer to the application table on page 4.

Ød ₁	P	l ₁	l ₂	l ₃	Ød ₂	a	N	type		identification number
UNC No2	- 56	45	9	-	2.8	2.1	2	1	1.85	780348
UNC No4	- 40	56	11	18	3.5	2.7	2	1	2.35	780349
UNC No5	- 40	56	11	18	3.5	2.7	3	1	2.65	780350
UNC No6	- 32	56	12	20	4	3	3	1	2.85	780351
UNC No8	- 32	63	13	21	4.5	3.4	3	1	3.5	780352
UNC No10	- 24	70	16	25	6	4.9	3	1	3.9	780353
UNC No12	- 24	80	17	30	6	4.9	3	1	4.5	780354
UNC 1/4"	- 20	80	19	30	7	5.5	3	1	5.1	780355
UNC 5/16"	- 18	90	22	35	8	6.2	3	1	6.6	780356
UNC 3/8"	- 16	100	24	39	10	8	3	1	8	780357
UNC 1/2"	- 13	110	28	-	9	7	3	2	10.8	780358
UNC 5/8"	- 11	110	32	-	12	9	3	2	13.5	780359
UNC 3/4"	- 10	125	34	-	14	11	3	2	16.5	780360
UNC 7/8"	- 9	140	34	-	18	14.5	3	2	19.5	780361
UNC 1"	- 8	160	38	-	18	14.5	3	2	22.25	780362

CUTTING TAPS FOR BLIND HOLE

UNC

Unified coarse thread ASME B1.1



series

**DOMINANT
LT45**

model

TIN

material

HSSE

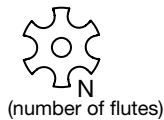
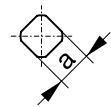
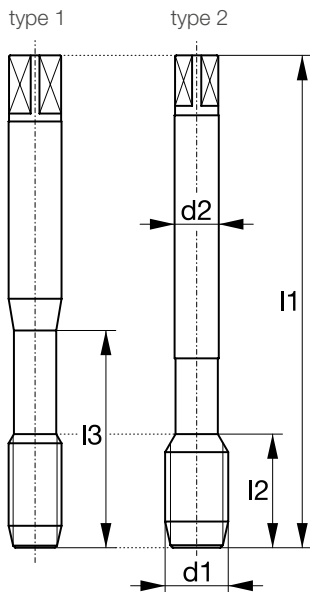

chamfer

C / 2-3

thread tol.

2BX

shank tol.

h9

thread depth

3xD

bore hole



General dimensions
DIN 2184-1

P

10 - 30

M

6 - 12

K

8 - 25

N

10 - 40

i For detailed cutting speeds please refer to the application table on page 4.

Ød ₁	P	l ₁	l ₂	l ₃	Ød ₂	a	N	type		identification number
UNC No2	- 56	45	3.6	11	2.8	2.1	2	1	1.85	780363
UNC No3	- 48	50	3.6	13	2.8	2.1	2	1	2.1	780364
UNC No4	- 40	56	5.1	18	3.5	2.7	2	1	2.35	780365
UNC No5	- 40	56	5.1	18	3.5	2.7	2	1	2.65	780366
UNC No6	- 32	56	6.4	20	4	3	2	1	2.85	780367
UNC No8	- 32	63	6.4	21	4.5	3.4	2	1	3.5	780368
UNC No10	- 24	70	8.5	25	6	4.9	2	1	3.9	780369
UNC No12	- 24	80	8.5	30	6	4.9	2	1	4.5	780370
UNC 1/4"	- 20	80	10.2	30	7	5.5	2	1	5.1	780371
UNC 5/16"	- 18	90	11.3	35	8	6.2	3	1	6.6	780372
UNC 3/8"	- 16	100	12.7	39	10	8	3	1	8	780373
UNC 1/2"	- 13	110	15.6	-	9	7	3	2	10.8	780374
UNC 5/8"	- 11	110	18.5	-	12	9	3	2	13.5	780375
UNC 3/4"	- 10	125	25.4	-	14	11	4	2	16.5	780376
UNC 7/8"	- 9	140	28.2	-	18	14.5	4	2	19.5	780377
UNC 1"	- 8	160	31.8	-	18	14.5	4	2	22.25	780378

CUTTING TAPS FOR THROUGH HOLE

UNF

Unified fine thread
ASME B1.1



series
model
material

VARIANT
LT
TIN
HSSE

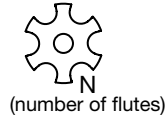
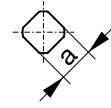
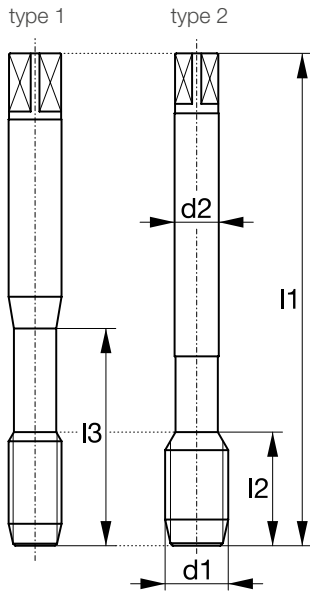

General dimensions
DIN 2184-1

chamfer	B / 3-5.5			
thread tol.	2BX			
shank tol.	h9			
thread depth	3xD			
bore hole				
P	10 - 30			
M	6 - 12			
K	5 - 25			
N	10 - 40			

i For detailed cutting speeds please refer to the application table on page 4.

Ød ₁	P	l ₁	l ₂	l ₃	Ød ₂	a	N	type		identification number
UNF No2	- 64	45	9	-	2.8	2.1	2	1	1.85	780379
UNF No3	- 56	50	9	-	2.8	2.1	2	1	2.15	780380
UNF No4	- 48	56	11	18	3.5	2.7	2	1	2.4	780381
UNF No5	- 44	56	11	18	3.5	2.7	3	1	2.7	780382
UNF No6	- 40	56	12	20	4	3	3	1	2.95	780383
UNF No8	- 36	63	13	21	4.5	3.4	3	1	3.5	780384
UNF No10	- 32	70	16	25	6	4.9	3	1	4.1	780385
UNF 1/4"	- 28	80	19	30	7	5.5	3	1	5.5	780386
UNF 5/16"	- 24	90	22	35	8	6.2	3	1	6.9	780387
UNF 3/8"	- 24	90	20	35	10	8	3	1	8.5	780388
UNF 7/16"	- 20	100	24	-	8	6.2	3	2	9.9	780389
UNF 1/2"	- 20	100	22	-	9	7	3	2	11.5	780390
UNF 9/16"	- 18	100	22	-	11	9	3	2	12.9	780391
UNF 5/8"	- 18	100	22	-	12	9	3	2	14.5	780392
UNF 3/4"	- 16	110	25	-	14	11	3	2	17.5	780393
UNF 7/8"	- 14	125	25	-	18	14.5	3	2	20.4	780394
UNF 1"	- 12	140	28	-	18	14.5	3	2	23.25	780395

CUTTING TAPS FOR BLIND HOLE

UNF

Unified fine thread
ASME B1.1



series
model
material

DOMINANT
LT45
TIN
HSSE

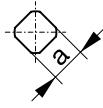
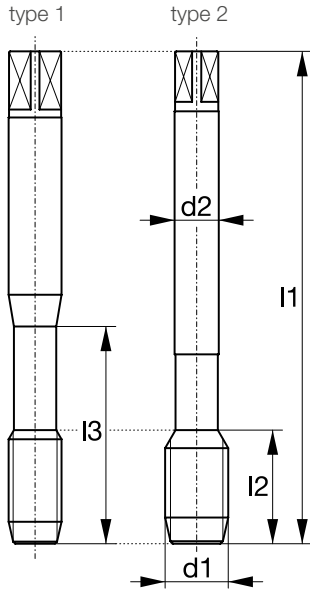

chamfer

C / 2-3

thread tol.

2BX

shank tol.

h9

thread depth

3xD

bore hole



General dimensions
DIN 2184-1

P

10 - 30

M

6 - 12

K

8 - 25

N

10 - 40

i For detailed cutting speeds please refer to the application table on page 4.

Ød ₁	P	l ₁	l ₂	l ₃	Ød ₂	a	N	type		identification number
UNF No2	- 64	45	3.6	11	2.8	2.1	2	1	1.85	780396
UNF No3	- 56	50	3.6	13	2.8	2.1	2	1	2.15	780397
UNF No4	- 48	56	5.1	18	3.5	2.7	2	1	2.4	780398
UNF No5	- 44	56	5.1	18	3.5	2.7	2	1	2.7	780399
UNF No6	- 40	56	6.4	20	4	3	2	1	2.95	780400
UNF No8	- 36	63	6.4	21	4.5	3.4	2	1	3.5	780401
UNF No10	- 32	70	8.5	25	6	4.9	2	1	4.1	780402
UNF No12	- 28	80	8.5	30	6	4.9	2	1	4.6	780403
UNF 1/4"	- 28	80	10.2	30	7	5.5	2	1	5.5	780404
UNF 5/16"	- 24	90	11.3	35	8	6.2	3	1	6.9	780405
UNF 3/8"	- 24	90	12.7	35	10	8	3	1	8.5	780406
UNF 7/16"	- 20	100	14.5	-	8	6.2	3	2	9.9	780407
UNF 1/2"	- 20	100	15.6	-	9	7	3	2	11.5	780408
UNF 9/16"	- 18	100	16.9	-	11	9	3	2	12.9	780409
UNF 5/8"	- 18	100	18.5	-	12	9	3	2	14.5	780410
UNF 3/4"	- 16	110	25.4	-	14	11	4	2	17.5	780411
UNF 7/8"	- 14	125	28.2	-	18	14.5	4	2	20.4	780412
UNF 1"	- 12	140	31.8	-	18	14.5	4	2	23.25	780413

CUTTING TAPS FOR THROUGH HOLE

**STI
EG-M**

STI Metric ISO
thread DIN 8140



series
model
material

VARIANT
LT
TIN
HSSE

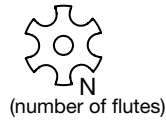
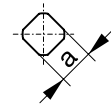
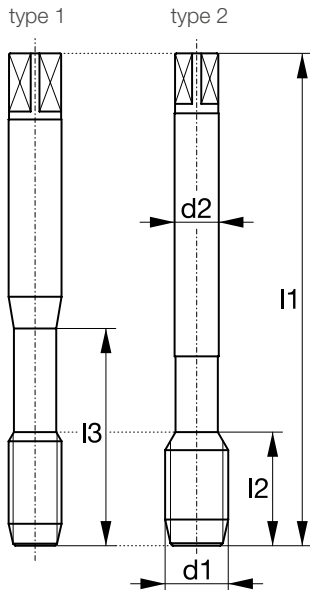

**General dimensions
DIN 40435**

chamfer	B / 3-5.5			
thread tol.	6HX mod			
shank tol.	h9			
thread depth	3xD			
bore hole				
P	10 - 30			
M	6 - 12			
K	5 - 25			
N	10 - 40			

i For detailed cutting speeds please refer to the application table on page 4.

$\varnothing d_1$	P	l_1	l_2	l_3	$\varnothing d_2$	a	N	type		identification number
EG-M 2	0.4	50	9	-	2.8	2.1	2	1	2.1	780292
EG-M 2.5	0.45	56	11	18	3.5	2.7	3	1	2.65	780293
EG-M 3	0.5	63	13	21	4.5	3.4	3	1	3.15	780294
EG-M 4	0.7	70	16	25	6	4.9	3	1	4.2	780295
EG-M 5	0.8	80	19	30	6	4.9	3	1	5.25	780296
EG-M 6	1	90	22	35	8	6.2	3	1	6.3	780297
EG-M 8	1.25	100	24	39	10	8	3	1	8.4	780298
EG-M 10	1.5	100	29	-	9	7	3	2	10.5	780299
EG-M 12	1.75	110	30	-	11	9	3	2	12.5	780300
EG-M 16	2	125	34	-	14	11	3	2	16.5	780301
EG-M 20	2.5	160	34	-	18	14.5	3	2	20.8	780302

CUTTING TAPS FOR BLIND HOLE

STI
EG-M

STI Metric ISO
thread DIN 8140



series

model

material

DOMINANT
LT45
TIN
HSSE

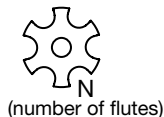
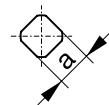
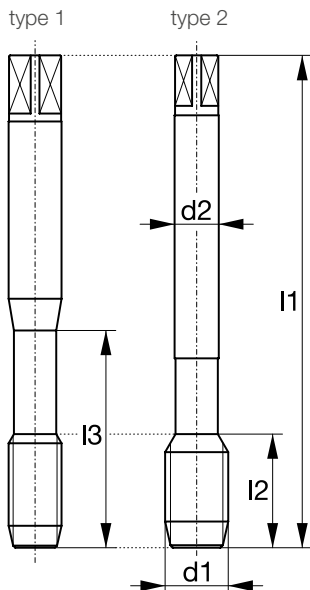

chamfer

E / 1.5-2

thread tol.

6HX mod

shank tol.

h9

thread depth

3xD

bore hole



General dimensions
DIN 40435

P

10 - 30

M

6 - 12

K

8 - 25

N

10 - 40

i For detailed cutting speeds please refer to the application table on page 4.

$\varnothing d_1$	P	l_1	l_2	l_3	$\varnothing d_2$	a	N	type		identification number
EG-M 2	0.4	50	4.5	13	2.8	2.1	2	1	2.1	780303
EG-M 2.5	0.45	56	5	18	3.5	2.7	3	1	2.65	780304
EG-M 3	0.5	63	5	21	4.5	3.4	3	1	3.15	780305
EG-M 4	0.7	70	7	25	6	4.9	3	1	4.2	780306
EG-M 5	0.8	80	8	30	6	4.9	3	1	5.25	780307
EG-M 6	1	90	10	35	8	6.2	3	1	6.3	780308
EG-M 8	1.25	100	13	39	10	8	3	1	8.4	780309
EG-M 10	1.5	100	15	-	9	7	3	2	10.5	780310
EG-M 12	1.75	110	18	-	11	9	3	2	12.5	780311
EG-M 16	2	125	20	-	14	11	4	2	16.5	780312
EG-M 20	2.5	160	25	-	18	14.5	4	2	20.8	780313

CUTTING TAPS FOR THROUGH AND BLIND HOLE

NPT	American standard taper pipe thread ASME B1.20.3 tapered 1:16		series	DOMINANT LT40			
			model	TIN			
			material	HSSE			

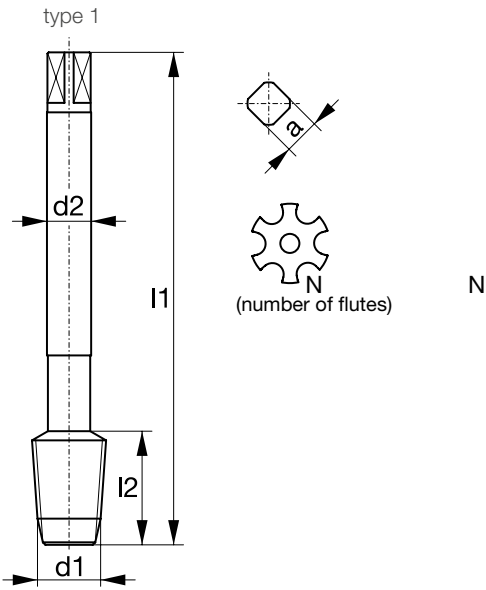

chamfer	C / 2-3			
thread tol.	-			
shank tol.	h9			
thread depth	-			
bore hole				
P	2-8			
M	-			
K	1-8			
N	1-8			

General dimensions
~ DIN 5156

i For detailed cutting speeds please refer to the application table on page 4.

Ød ₁	P	l ₁	l ₂	l ₃	Ød ₂	a	N	type		identification number
NPT 1/16"	27	90	18	-	6	4.9	3	2	6.15	780414
NPT 1/8"	27	90	19	-	7	5.5	3	2	8.4	780415
NPT 1/4"	18	100	28	-	11	9	3	2	11.1	780416
NPT 3/8"	18	100	28	-	12	9	4	2	14.3	780417
NPT 1/2"	14	125	35	-	16	12	4	2	17.9	780418
NPT 3/4"	14	140	35	-	20	16	4	2	23.2	780419
NPT 1"	11.5	160	45	-	25	20	4	2	29	780420

NOTES

A large grid of small dots, intended for taking notes. The grid consists of approximately 30 columns and 40 rows of dots, covering most of the page area.

NOTES

A large grid of small dots for taking notes, covering most of the page.

Discover our main catalogue...



BASS
TECHNIK FÜR GEWINDE

Gewindelocher
colt tipo / taraute à l'interieur / resaca à rotare / tamboreadora

Typenbezeichnung / type / tipo / tipo / tipo

	DURAMAX 1 H	DURAMAX 1 M	DURAMAX 1 H	DURAMAX 1 M
M-Metrisches ISO-Rohrgewinde DIN 13 ISO Metric coarse thread DIN 13 Rosaço metrisco ISO-DIN 13 Rosca metrisca ISO-DIN 13	[Image showing thread form]			
DIN 2174	[Image showing thread form]			
Bezeichnung / name / type de taraute / tipo / tipo de agujero	[Image showing thread form]			
Einsatzgebiet / application / aplicación adatto per lavorazione di / aplicación	[Image showing thread form]			
Ausführung / model / realización / modelo / modelo	HN	KA TN	K3 TN	TN
Werkstoff / tool material / substrate / matériau / matériau	HSSE-PM	HSSE-PM	HSSE-PM	HSSE-PM
Gewindelösung / Thread clearance / toléncia de toleránz / toléncia de fabricación / tolerancia de fabricación	H9	H9	H9	H9
Schulftoleranz / internal tolerance / toléncia de ajuste / toléncia de ajuste / toléncia de ajuste	H6	H6	H6	H6
Abschnitt / chamfer / rebaba / reboco / reboca	G/2-3	C/2-3	C/2-3	G/2-3

Ød	P	L	l ₁	l ₂	Øk	z	CT	BT	ID
M 3	0,5	55	10	18	3,2	2,0		107136	
M 4	0,7	63	12	21	4,5	3,4	3,7	107194	
M 5	0,8	79	14	25	5	4,9	4,65	107196	107200
M 6	1	80	16	30	6	4,9	5,55	107222	107241
M 8	1,25	90	18	35	8	6,2	7,25	107291	104791
M 10	1,5	100	20	40	10	8	9,25	107196	004728

BASS
TECHNIK FÜR GEWINDE

Gewindelocher
colt tipo / taraute à l'interieur / resaca à rotare / tamboreadora

Typenbezeichnung / type / tipo / tipo / tipo

	DURAMAX 2 H	DURAMAX 2 M	DURAMAX 2 H
M-Metrisches ISO-Rohrgewinde DIN 13 ISO Metric coarse thread DIN 13 Rosaço metrisco ISO-DIN 13 Rosca metrisca ISO-DIN 13	[Image showing thread form]		
DIN 2174	[Image showing thread form]		
Bezeichnung / name / type de taraute / tipo / tipo de agujero	[Image showing thread form]		
Einsatzgebiet / application / aplicación adatto per lavorazione di / aplicación	[Image showing thread form]		
Ausführung / model / realización / modelo / modelo	TN	KA TN	K3 TN
Werkstoff / tool material / substrate / matériau / matériau	HSSE-PM	HSSE-PM	HSSE-PM
Gewindelösung / Thread clearance / toléncia de toleránz / toléncia de fabricación / tolerancia de fabricación	H9	H9	H9
Schulftoleranz / internal tolerance / toléncia de ajuste / toléncia de ajuste / toléncia de ajuste	H6	H6	H6
Abschnitt / chamfer / rebaba / reboco / reboca	G/2-3	G/2-3	G/2-3

Ød	P	L	l ₁	l ₂	Øk	z	CT	BT	ID
M 17	1,75	130	24	5	7	11,3		030146	030107
M 18	2	110	25	11	8	13,1		024814	030107
M 18	2	110	27	12	8	15,1		107246	030117
M 18	2,5	128	33	14	11	16,3		030136	030136
M 20	2,5	140	32	16	12	18,8		020147	016105
M 22	2,5	140	32	16	14,8	20,8		030154	020147
M 24	3	160	38	18	14,8	22,8		024715	030161
M 27	3	160	39	20	18	25,5		061308	030176
M 30	3,5	180	40	22	18	28,3		048025	030187
M 33	3,5	180	40	25	20	31,5		061309	030187
M 36	4	200	45	28	22	34,1		020146	030187
M 39	4	200	50	30	24	37,1		061110	030187
M 42	4,5	200	55	32	24	39,8		048158	030187
M 45	4,5	200	55	36	28	42,8		030113	030184
M 48	5	210	60	36	29	45,8		056158	030184

and our catalogue for thread milling cutters!



BASS
TECHNIK FÜR GEWINDE

WM-Gewindelocher GFA
colt grande fresca milling cutter GFA / fresca à rotar GFA en carburo metalúrico / taraute à l'extérior en métal dur GFA / fresca de rosca de metal duro GFA

Typenbezeichnung / type / tipo / tipo / tipo

	GFA N	GFA N
Metrisches ISO-Feingewinde DIN 13 ISO Metric fine thread DIN 13 Rosaço metrisco ISO à uso P-DIN 13 Rosca metrisca ISO para uso P-DIN 13	[Image showing thread form]	
Gewindelösung / Thread clearance / toléncia de toleránz / toléncia de fabricación / tolerancia de fabricación	2 x D	2 x D
Einsatzgebiet / application / aplicación adatto per lavorazione di / aplicación	1,1-1,8 / 2 / 2,5 3 / 3,5 / 4 / 4,7 5 / 5,6 / 6 / 6,3 8 / 8,8 / 9 / 9,9 11 / 12	1,1-1,8 / 2 / 2,5 3 / 3,5 / 4 / 4,7 5 / 5,6 / 6 / 6,3 8 / 8,8 / 9 / 9,9 11 / 12
Zylinderschaft / straight shank / eixo cilíndrico / gamba cilindrica / mango cilíndrico	DN 805-NA	DN 805-NA
Ausführung / model / realización / modelo / modelo	KA	KA TCN

ØD	P	L	l ₁	Øk	z	CT	BT	ID		
SN 8	x 0,75	54	19	4,00	6	3	12	125	0,7	009105
SN 8	x 1	64	18	5,00	6	3	16	105	7,2	020003
MF 10	x 1	64	22	7,00	8	4	20	235	9,0	009110
SN 10	x 1,25	64	22	7,00	8	4	30	210	8,8	005110
MF 12	x 1	74	26	9,00	10	4	24	245	11,0	020114
SN 12	x 1,5	74	26	8,85	10	4	24	250	10,5	005110
SN 14	x 1,5	80	28	11,90	12	4	28	290	12,8	007225
MF 18	x 1,5	90	34	15,90	14	4	30	330	14,5	061257

BASS
TECHNIK FÜR GEWINDE

WM-Gewindelocher GFA
colt grande fresca milling cutter GFA / fresca à rotar GFA en carburo metalúrico / taraute à l'extérior en métal dur GFA / fresca de rosca de metal duro GFA

Typenbezeichnung / type / tipo / tipo / tipo

	GFA N
G-Rohrgewinde DIN ISO 228 ISO Metric coarse thread DIN ISO 228 Rosaço para uso GFA ISO-DIN 228 Rosca para tubo normal bruto ISO-DIN 228	[Image showing thread form]
Gewindelösung / Thread clearance / toléncia de toleránz / toléncia de fabricación / tolerancia de fabricación	2 x D
Einsatzgebiet / application / aplicación adatto per lavorazione di / aplicación	1,1-1,8 / 2 / 2,5 3 / 3,5 / 4 / 4,7 5 / 5,6 / 6 / 6,3 8 / 8,8 / 9 / 9,9 11 / 12
Zylinderschaft / straight shank / eixo cilíndrico / gamba cilindrica / mango cilíndrico	DN 805-NA
Ausführung / model / realización / modelo / modelo	KA TCN

ØD	P	L	l ₁	Øk	z	CT	BT	ID		
G 18	2,5	84	21	7,00	8	4	24	235	8,8	067240
G 14	1,9	74	20	9,90	10	4	28	275	11,0	007155
G 38	1,9	30	35	15,00	14	4	34	345	15,25	107154
G 12	1,4	120	44	15,90	16	5	40	42	19	067220

BASS GmbH

Technik für Gewinde
Bass-Strasse 1
97996 Niederstetten
Deutschland · Germany

Tel.: +49 7932 892-0
Fax: +49 7932 892-87
E-Mail: info@bass-tools.com
Web: www.bass-tools.com



VDA AUTOMOTIVE QUALITY
6.4
MANAGEMENT SYSTEMS

ISO QUALITY
9001
MANAGEMENT SYSTEMS

ISO ENVIRONMENTAL
14001
MANAGEMENT SYSTEMS

ISO ENERGY
50001
MANAGEMENT SYSTEMS

PDF DOWNLOAD



ZIBTRPRO
tehnologija obdelave · vpenjalni sistemi